

Schottky Barrier Rectifier

Features

- V_R 20V/30V/40V
- I_{FAV} 1A

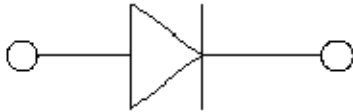

Typical Applications

- Extreme fast switches

Mechanical Data

- **Package:** SOD-323
- **Terminals:** Tin plated leads, solderable per J-STD-002 and JESD22-B102
- **Polarity:** Cathode line denotes the cathode end

	Marking
B5817WS	SJ
B5818WS	SK
B5819WS	SL

■ Maximum Ratings (Ta=25°C Unless otherwise specified)

PARAMETER	SYMBOL	UNIT	Conditions	VALUE	
Repetitive peak reverse voltage	V_{RRM}	V		B5817WS	20
				B5818WS	30
				B5819WS	40
Reverse voltage	V_R	V	$I_R=1mA$	B5817WS	20
				B5818WS	30
				B5819WS	40
Peak forward surge current	I_{FSM}	A	$t_p=8.3ms$, half sine	10	
Average forward current	I_{FAV}	A		1	
Maximum junction temperature	T_j	°C		-65 to +125	
Storage temperature range	T_{stg}	°C		-65 to +150	
Thermal Resistance Junction to Ambient Air	$R_{\theta JA}$	°C /W		500	



B5817WS THRU B5819WS

■ Electrical Characteristics (T_a=25°C Unless otherwise specified)

PARAMETER	SYMBOL	UNIT	Conditions		VALUE	
Maximum Forward voltage	V _F	V	I _F =1A, T _J =25°C	B5817WS	0.45	
				B5818WS	0.55	
				B5819WS	0.60	
	V _F	V	I _F =3A, T _J =25°C	B5817WS	0.75	
				B5818WS	0.875	
				B5819WS	0.90	
Maximum Reverse current	I _R	μA	B5817WS	V _R =20V, T _A =25°C	200	
			B5818WS	V _R =30V, T _A =25°C	40	
			B5819WS	V _R =40V, T _A =25°C	40	
Minimum Breakdown voltage	V _(BR)	V	I _R =1mA	B5817WS	20	
				B5818WS	30	
				B5819WS	40	
Maximum Diode capacitance	C _D	pF	V _R =4V, f=1MHz		120	

■ Ordering Information (Example)

PREFERRED P/N	PACKING CODE	UNIT WEIGHT(g)	MINIMUM PACKAGE(pcs)	INNER BOX QUANTITY(pcs)	OUTER CARTON QUANTITY(pcs)	DELIVERY MODE
B5817WS Thru B5819WS	F2	Approximate 0.0048	3000	30000	120000	7" reel

■ Characteristics (Typical)

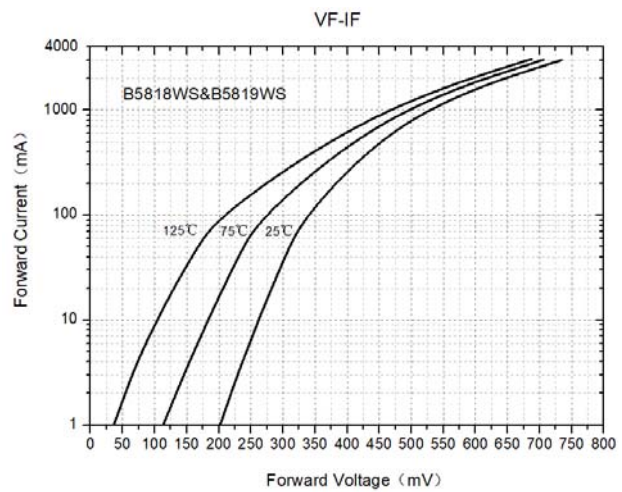
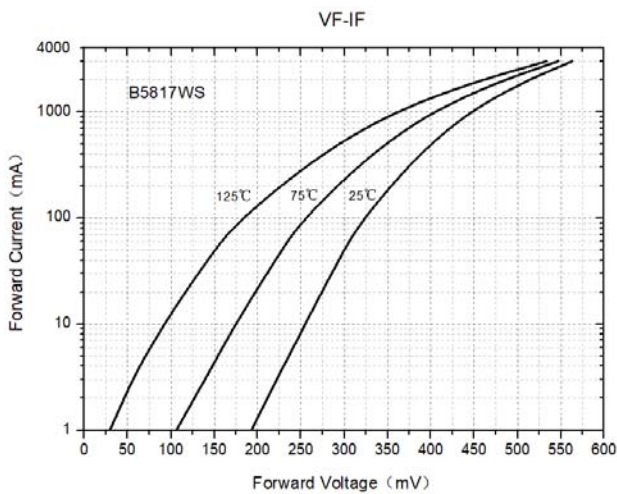



B5817WS THRU B5819WS

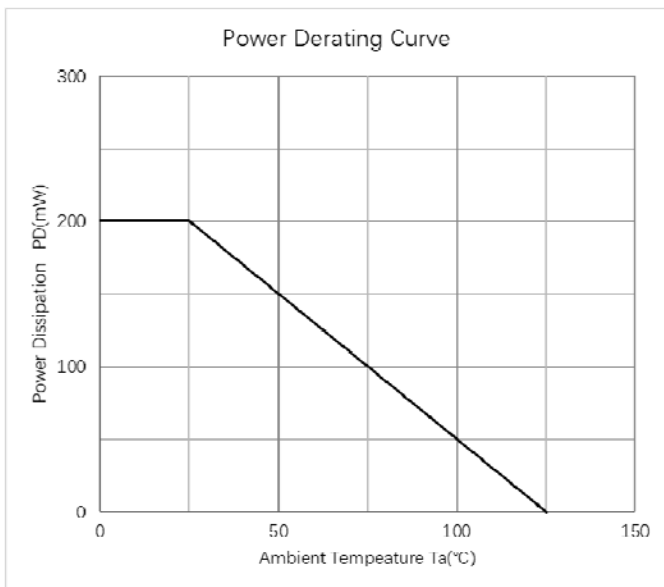
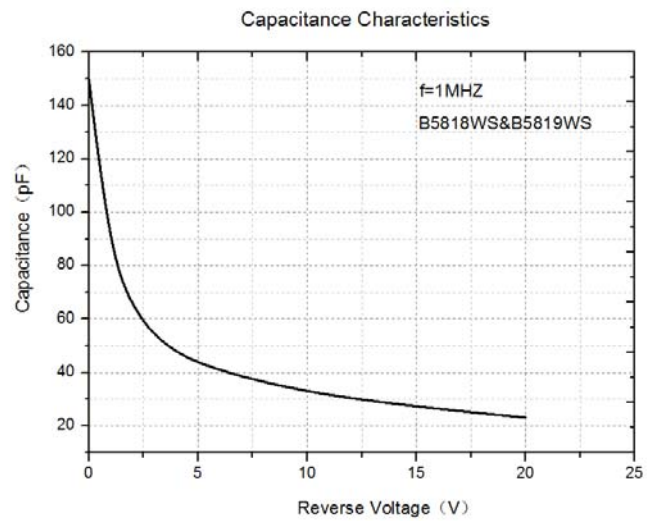
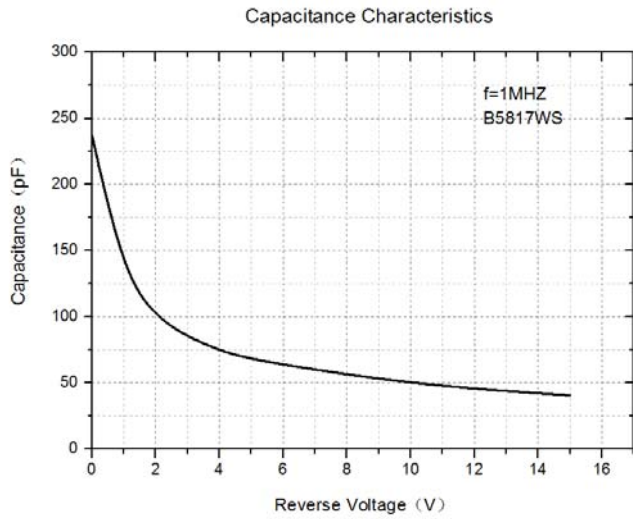
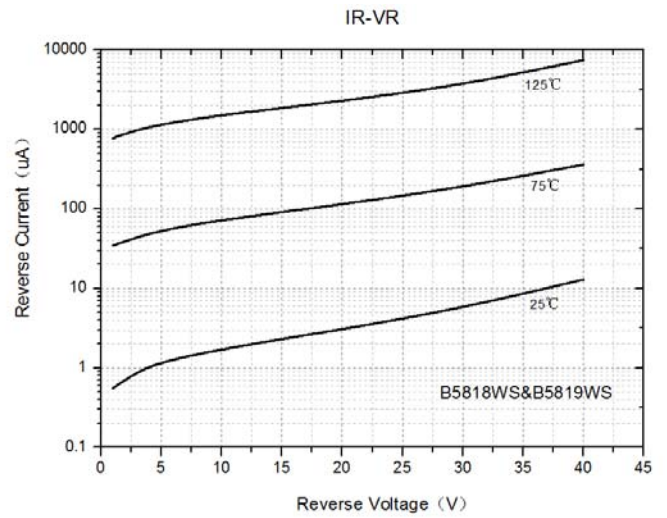
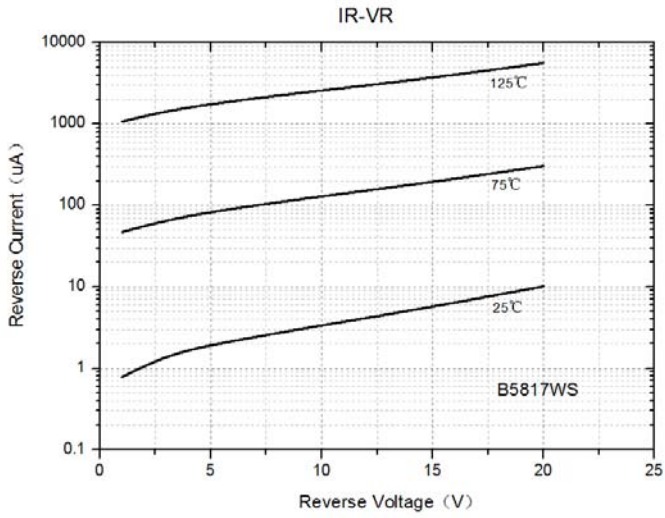



B5817WS THRU B5819WS

■Outline Dimensions

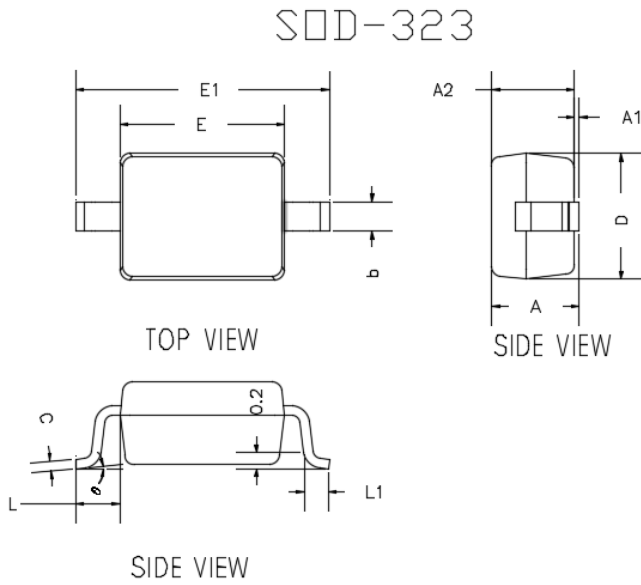

DIMENSIONS				
DIM	INCHES		MM	
	MIN	MAX	MIN	MAX
A	---	0.0393	---	1.0000
A1	0.0000	0.0039	0.0000	0.1000
A2	0.0314	0.0354	0.8000	0.9000
b	0.0098	0.0157	0.2500	0.4000
c	0.0031	0.0059	0.0800	0.1500
D	0.0472	0.0551	1.2000	1.4000
E	0.0629	0.0709	1.6000	1.8000
E1	0.0984	0.1063	2.5000	2.7000
L	0.0187TYP		0.475TYP	
L1	0.0098	0.0157	0.250	0.400
θ	0°	8°	0°	8°

■Soldering Footprint

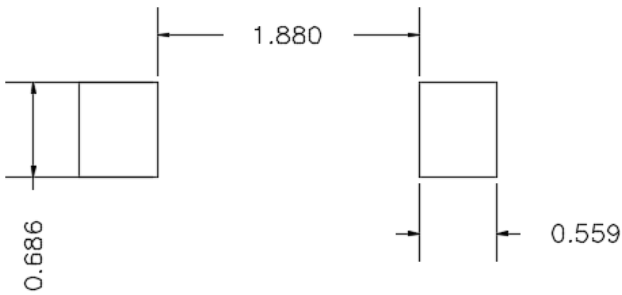

UNIT : mm

SUGGESTED SOLDER PAD LAYOUT



B5817WS THRU B5819WS

Disclaimer

The information presented in this document is for reference only. Yangzhou Yangjie Electronic Technology Co., Ltd. reserves the right to make changes without notice for the specification of the products displayed herein to improve reliability, function or design or otherwise.

The product listed herein is designed to be used with ordinary electronic equipment or devices, and not designed to be used with equipment or devices which require high level of reliability and the malfunction of which would directly endanger human life (such as medical instruments, transportation equipment, aerospace machinery, nuclear-reactor controllers, fuel controllers and other safety devices), Yangjie or anyone on its behalf, assumes no responsibility or liability for any damages resulting from such improper use of sale.

This publication supersedes & replaces all information previously supplied. For additional information, please visit our website [http:// www.21yangjie.com](http://www.21yangjie.com) , or consult your nearest Yangjie's sales office for further assistance.